

1 Water Seal

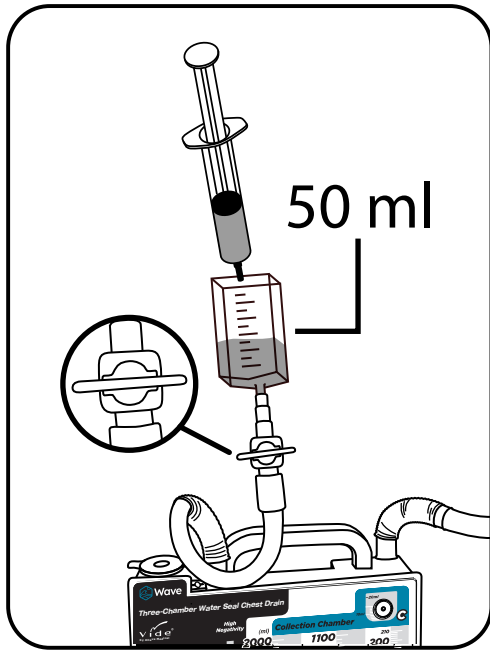

2 Suction Control

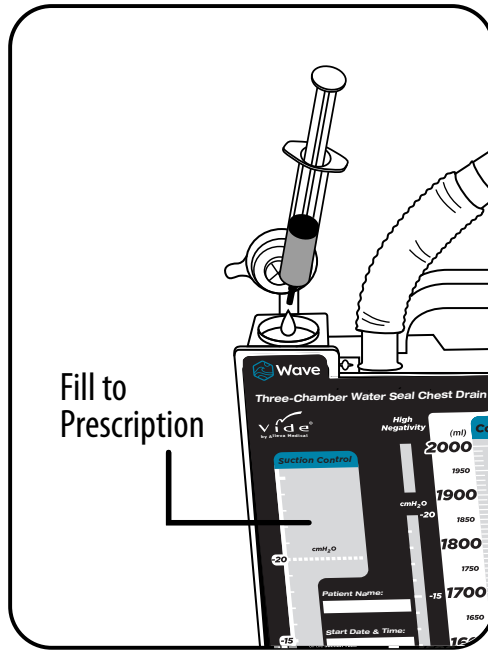

3 Patient Tube

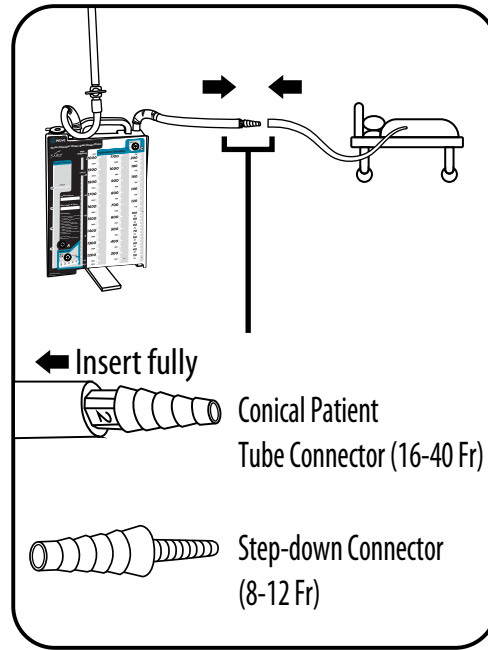

4 Suction Source

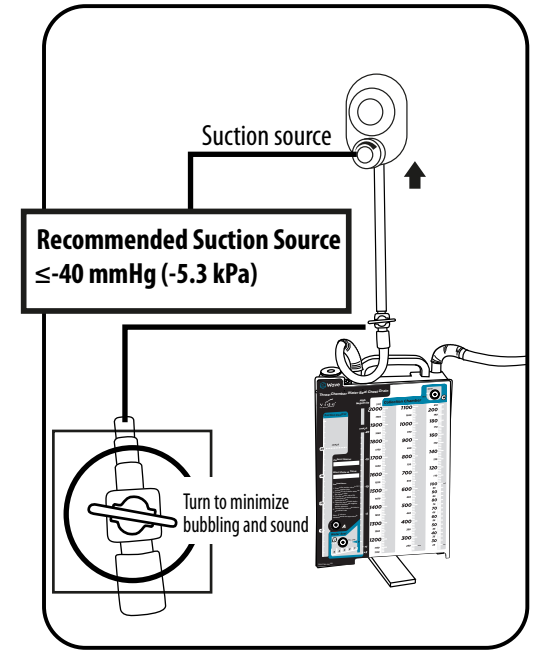

5 Normal Use for Suction Drainage

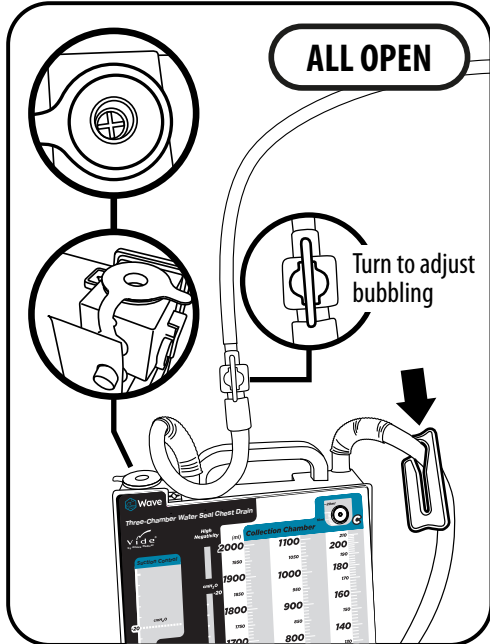

6 Suction to Gravity

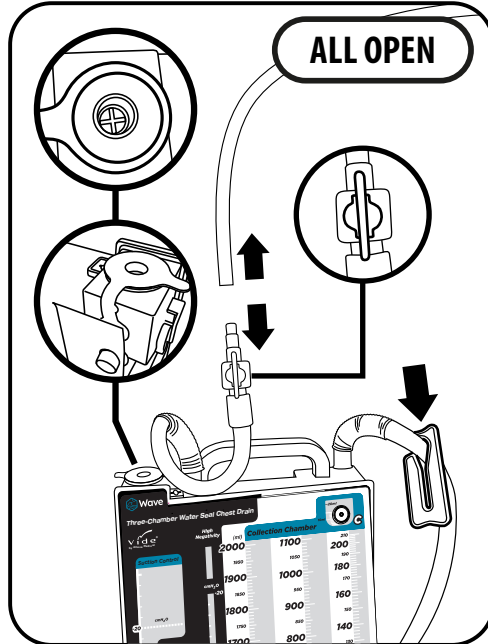

7 Sampling

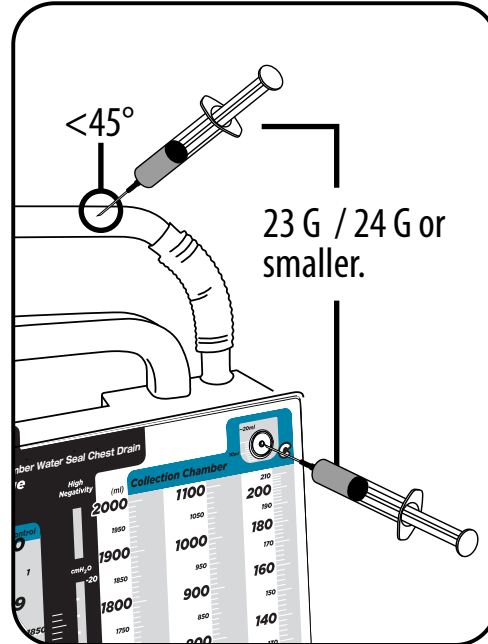

8 Disposal

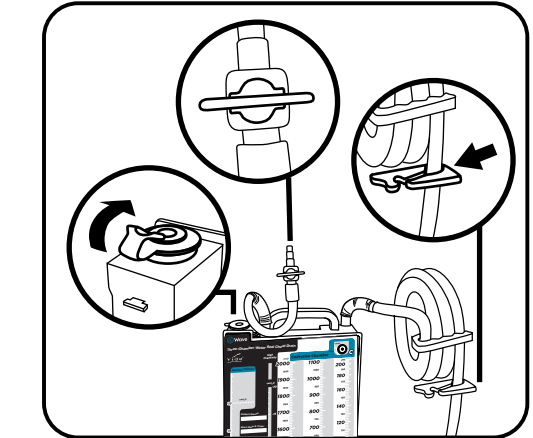

Wave™
Three-chamber Water Seal Chest Drain Quick Guide

REF: ST380-0001

See Video



©2025-01
 IFU2-ST380-100.002
 Date of issue: 2025-03-20